



European Journal of Psychology and Educational Research

Volume 5, Issue 2, 145 - 160.

ISSN: 2589-949X

<https://www.ejper.com>

The Rosenberg Self-esteem Scale: A Confirmatory Factor Analysis Study

Abdelouahed Bouih* 

Moulay Ismail University, MOROCCO

Driss Benattabou 

Moulay Ismail University, MOROCCO

Bendaoud Nadif 

Moulay Ismail University, MOROCCO

Mohamed Benhima 

Mohammed V University, MOROCCO

Ismail Benfilali 

Sidi Mohamed Ben Abdellah University, MOROCCO

Received: May 16, 2022 • Revised: September 8, 2022 • Accepted: October 19, 2022

Abstract: The aim of the present study is to conduct a confirmatory factor analysis (CFA) of the Rosenberg Self-esteem Scale (RSES) as part of the study of affective variables using a sample of English as a foreign language (EFL) university students in Morocco. Two hundred and six (N = 206) participants of undergraduate, graduate, and post-graduate levels completed the self-esteem (SE) questionnaire. Using classical methods of factor extraction before employing more robust techniques comprising minimum average partial (MAP) and parallel analysis (PA) to perform preliminary factor analysis (FA) using principal axis factoring (PAF), results conclusively and parsimoniously yielded a one-factor solution with acceptable construct reliability (Composite Reliability). CFA results, including goodness-of-fit indexes, confirmed that the one-factor model was better fitting compared to its competing independent two-factor counterpart, but marginally less so compared to the correlated version of the latter. Two out of the three constructed models showed good fit indexes, thus demonstrating the conformity of two measurement models with their respective hypothesized structural models. Furthermore, using the heterotrait-monotrait (HTMT) ratio, both two-factor models showed acceptable discriminant validity. The obtained results further corroborate both the one-factor and two-factor solutions reported in previous works for which we present new evidence from a Moroccan EFL context.

Keywords: Factor analysis, RSES, self-esteem, validity.

To cite this article: Bouih, A., Benattabou, D., Nadif, B., Benhima, M., & Benfilali, I. (2022). The Rosenberg self-esteem scale: A confirmatory factor analysis study. *European Journal of Psychology and Educational Research*, 5(2), 143-160. <https://doi.org/10.12973/ejper.5.2.143>

Introduction

Self-esteem is one of the most researched constructs in psychology (Branden & Archibald, 1982; Cast & Burke, 2002). Its relevance to multiple social and human sciences as well as other closely related disciplines cannot be overstated. Such factual evidence testifies to the strategic multidisciplinary importance of self-esteem in psychology and by extension to language learning and educational psychology (Dornyei & Ryan, 2015).

Generally speaking, in social and human sciences, complex constructs are destined to be reflective of the respective complex phenomena they purport to measure, and they naturally admit multiple conceptualizations depending on numerous factors (e.g., initial definition, measurement instrument, statistical tools, contextual elements, a priori suppositions, prior conceptualizations). In this sense, self-esteem as an underlying phenomenon (e.g., to psychology, linguistics, sociology) is no exception in these terms since different constructs tend to have more than one measurement instrument. In our case, we selected the Rosenberg Self-esteem Scale (RSES) as our object of factor analysis study for the self-esteem construct.

Accordingly, self-esteem has been conceptualized as a unidimensional, two-dimensional, and occasionally – at least theoretically – as a tridimensional construct. It follows logically that different conceptualizations of construct structures

* Corresponding author:

Abdelouahed Bouih, Moulay Ismail University, Morocco. ✉ abdelouahed.bouih@gmail.com



are conducive to different conclusions in the interpretation of results, which affects the descriptive and explanatory levels of the theory, as well as its predictive capacity.

Another reason that compels us to undertake this endeavor is the necessity to prior utilization of instruments – in our case, in the Moroccan EFL context – to any informed and justifiably founded deployment for future use. Otherwise stated, we are compelled to study the RSES structure and thereby make a factorial precedent of it, since the adoption of any particular factor structure of any construct supposes its demonstrable validity.

Therefore, with the intent to examine the RSES factorial structure through evaluating a set of its multiple competing models, the present work starts with a review of the literature focusing on various definitions and factor structure configurations of the RSES reported in previous works. The second part comprises the research methodology, results, and discussion, which are analytical and revolve essentially around confirmatory factor analysis (CFA), in addition to reliability and validity tests. Finally, we conclude by highlighting significant findings before making recommendations for future research.

Literature review

By virtue of the cross-cutting importance of self-esteem and its reliable consistency and relevance to multiple social and psychological phenomena (Orth et al., 2018) for it has demonstrably been shown to be related to different phenomena at different levels (Harris & Orth, 2020; Krauss et al., 2020; Monteiro et al., 2022; Perez-Gramaje et al., 2020; Rossier et al., 2022), both its construct definition and operationalization have had much attention just as they have been the object of multiple debates (Donnellan et al., 2011). It is likewise the case of many complex constructs in psychology and in related fields such as language studies, since multiple conceptualizations of self-esteem have been proposed. For instance, Baumeister and Tice (1985) look at it as a “global evaluation of the self” (p. 6), and however straightforward this definition might appear to be, it corresponds to multiple reported definition attempts made along similar lines. A case in point is where self-esteem is conceived of as the individual’s attitude about themselves, involving self-evaluation along a two-dimensional positive-negative spectrum (Baron & Byrne, 1991) being in principle reflective of one’s self-respect and self-worth and linked to both positive and negative affects (Monteiro et al., 2022). Similarly, Rosenberg et al. (1995, p.141) state that self-esteem is the “individual’s positive or negative attitude toward the self as a totality.” Interestingly enough, self-esteem has been also defined as the appraisal of one’s value, and an affective self-evaluation through which it is possible to assess one’s behavior or attributes evaluatively (Leary & Baumeister, 2000).

These definitions do not appear to be substantially dissimilar to the original definition of self-esteem as conceived of by Rosenberg (1965) since he considers self-esteem a global attitude toward oneself, be it positive or negative, and defines it as the individuals’ set of thoughts and feelings about their worth and importance. Perhaps an arguably maximally-synthesizing and comprehensive definition resembles what has been put forth by Rubio (2007) contending that self-esteem is:

“A psychological and social phenomenon in which an individual evaluates his/her competence and own self according to some values, which may result in different emotional states, and which becomes developmentally stable but is still open to variation depending on personal circumstances.” (p.5)

Self-esteem is believed to be one of the dimensions that make up the multi-dimensional higher-order construct self-concept along with but not limited to self-crystallization and stability factors (Rosenberg & Kaplan, 1982). In terms of characteristics, self-esteem is considered to be a relatively stable attribute and a contributing factor to general physical and mental health of an individual (Antonucci & Jackson, 1983). However, practically speaking, self-esteem reflects the belief in one’s ability to perform a given task (Brown, 2001). While there are several elaborated definitions for self-esteem particularly when it comes to construct operationalization, it has typically been conceptualized as a two-level hierarchical organization (Pierce et al., 1989).

Brown (2006) reports a multi-dimensional structure for the construct of self-esteem comprising three dimensions: global self-esteem, situational or specific self-esteem, and task self-esteem, and as far as multi-dimensionality goes, there are several propositions in that regard. One such conceptualization proposes three components of self-esteem (instrumental self-esteem, expectant self-esteem, and monitored self-esteem) (Higgins, 1996). Accordingly, global self-esteem is defined as the “individuals’ overall evaluation or appraisal of themselves, whether they approve or disapprove of themselves, like or dislike themselves” (Higgins, 1996, p. 1073) in a tripartite structure. A more common conception is based on a two-fold conceptualization proposed based on the dimensions of ‘Self-liking’ and ‘Self-competence’, representing respectively a sense of social worth, and a sense of personal efficacy (Tafarodi & Swann, 1995). Another instance of two-dimensional operationalization is reported in (Cast & Burke, 2002) where self-esteem is defined in this case in terms of two sub-constructs of Competence and Worth, as the former dimension is called “efficacy-based self-esteem” and it denotes “the degree to which people see themselves as capable and efficacious” (p. 1042), while the latter is called “worth-based self-esteem” and it refers to “the degree to which individuals feel they are persons of value” (p. 1042). Furthermore, a similar construction has been defined in terms of the two subscales of Self-depreciation and Self-confidence, with the former being associated to self-blame, lack of trust in others and how others

view one, whereas the latter is associated to kindness towards others and kindness and positivity towards oneself (Owens, 1993).

That said, the original Rosenberg scale was designed to be a global unidimensional self-esteem measure as far as validity goes (Rosenberg, 1965). Accordingly, it has shown good internal consistency, temporal stability (Fleming & Courtney, 1984), concurrent validity (Shevlin et al., 1995), and predictive validity (Roth & Altmann, 2020). Over the years, the RSES has gained increasingly more popularity and also criticism. The RSES has become considerably widespread that it was translated to over twenty-five languages (Schmitt & Allik, 2005). Since then, the RSES dimensionality question has been a topic of debate and there is much evidence in support for the multiple structures that have been reported (Supple et al., 2013).

A review of the relevant literature shows that studies overwhelmingly support both a unidimensional and a two-dimensional structure. In fact, a great many studies based on multiple variations of the RSES involving diverse cultural samples spanning over multiple populations supported both a one-factor model and a two-factor model (e.g., Corwyn, 2000; McKay et al., 2014; Pearlin & Schooler, 1978; Schmitt & Allik, 2005; Supple et al., 2013). The first competing model against the unidimensional conception of the RSES is based on a two-factor structure. In the literature, there is indeed considerable evidence in support of it (e.g., Bae et al., 2014; Boduszek et al., 2013; Goldsmith, 1986; Supple & Plunkett, 2011). However, it is essential to point that evidence tilts towards the uni-dimensionality of the RSES across various populations and using multiple languages (Franck et al., 2008; Huang & Dong, 2012; Marsh et al., 2010; Pullmann & Allik, 2000; Shevlin et al., 1995; Zimprich et al., 2005).

Ample evidence, mainly CFA studies, has confirmed the one-dimensional structure of the RSE construct in a wide range of settings including the Spanish (Martín-Albo et al., 2007; Mayordomo et al., 2020), Thai (Beeber et al., 2007; Wongpakaran & Wongpakaran, 2011), Dutch (Franck et al., 2008), German (Roth et al., 2008), Estonian (Pullmann & Allik, 2000), Swedish (Eklund et al., 2018), Northern Irish (Shevlin et al., 1995), French (Aluja et al., 2007), Italian (Salerno et al., 2017) Portuguese (Tomas & Oliver, 1999; Vasconcelos-Raposo et al., 2012), Slovak (Halama, 2008), and American (Greenberger et al., 2003) contexts, as well as in the UK (McKay et al., 2014). More comprehensively, recent meta-analytic cross-cultural evidence further demonstrates how the one-factor structure captures best the self-esteem phenomenon in a factor-analytical configuration (Gnambs et al., 2018). On the other hand, there exist similar CFA studies supporting a two-dimensional construction as well (e.g., Boduszek et al., 2013; Gnambs & Schroeders, 2020; Kielkiewicz et al., 2020; Owens, 1993; Xu & Leung, 2018) with comparable studies privileging the sub-construct and trait levels rather than a global construct approach (García et al., 2019).

Likewise, the RSES has been used in Arab-minority environments and Arab contexts mainly in the Middle East (e.g., Abdel-Khalek et al., 2012; Abu-Saad, 1999; Al Khatib, 2012; Savaya, 1998). But, it has nonetheless been less used in Morocco and Moroccan-minority contexts as it is the case in (e.g., Schmitt & Allik, 2005; Verkuyten, 2003).

Surprisingly enough, our survey of the related literature lead us to a sparsely insufficient number of studies of which there is one outstandingly notable work involving factorial analysis examining the RSES structure using in part a Moroccan sample, namely that by Schmitt and Allik (2005). Drawing on Principal Component Analysis (PCA) results, the findings of this large-scale study involving more than fifty countries including several African nations and two Arab countries (Morocco and Lebanon) reveal that the RSES was practically invariant across the various nations indicating a universal global unidimensional structure (Schmitt & Allik, 2005).

The state-of-the-art distinctly manifests a gap in the literature that warrants further attention and more investigations making research on factor analysis of the RSES in a Moroccan context nothing less of a pressing issue, particularly for social scientists and researchers in the underexplored Pan-African sphere. In light of this, the purpose of the present study is to contextualize and implement CFA to evaluate the fitness of three competing measurement models of the RSES relying on data obtained from a Moroccan university context. To provide additional support for the appropriateness of the measurement structures identified in the CFA, tests of internal reliability were carried out.

Methodology

Research Design

The purpose of the present investigation is to validate the RSE scale using primarily CFA techniques, and to look for empirical evidence in support of the proposed RSES model conceptualizations in order to evaluate their fitness, focusing on the subconstructs and the overall construct simultaneously. For this, multiple statistical procedures are used during the different factor analysis stages.

Initially, we investigate the number of underlying factors of the RSES using principal axis factoring (PAF), which is one of the common methods used to reduce the dimensionality of observed data into factorized components. In addition to PAF, Horn's (1965) parallel analysis (PA) and Velicer's (1976) minimum average partial (MAP) are used since they are both considered robust methods for considerably more reliable factor retention than the classical alternatives (e.g., Kaiser-Guttman rule) (Courtney & Gordon, 2013; Ledesma & Valero-Mora, 2007). The obtained model is then

compared to two versions of the original two-factor based model, of which one factor comprises positively worded items and the other includes negatively worded items as constructed by the original author (Rosenberg, 1965).

Further, all the models obtained are examined for their consistency using composite reliability (CR) which shows the level of consistency of items constituting a latent factor (Hair et al., 2019) before being evaluated in terms of convergent validity through the average variance extracted (AVE) which is in turn used to measure the convergence between the variables making the latent factor (Hair et al., 2019). Finally, we use the hetero-trait mono-trait (HTMT) ratio to evaluate the discriminant validity of the underlying factors in different models (Hair et al., 2019).

Research Questions and Hypotheses

Based on the reviewed literature and the different configurations of the self-esteem construct, we put forth two essential hypotheses emanating from one research question to the test in the Moroccan context:

Q1) From the proposed RSES factor structure conceptualizations (One-factor, independent two-factor, and restrained two-factor structures), what is the most fitting factor structure?

- H1) The one-factor model of the RSES is better fitting than both the restrained two-factor model and the independent two-factor model.
- H2) The restrained two-factor model of the RSES is more fitting than the independent two-factor model.

Participants and Procedures of Analysis

The sample comprises 123 (60%) male students and 83 (40%) female students of the total 206 participants. The most frequent age bracket is 20-25 year old individuals making nearly (36%) followed by 25-30 years old participants making approximately (27%) of the sample. The remaining part of the sample is composed of age groups of 30-35 (17%), 35-40 (12%), and 40-or-more making up (8%). In terms of academic qualifications, the most recurrent diploma reported is the B.A. representing roughly (35%) while 59 of the participants (29%) reported having a Master's Degree. 49 participants (24%) reported having a two-year degree, 18 (8%) a high school degree (up to the point when they are part of an undergraduate program), and 8 (4%) with a doctoral degree. Universities targeted span over multiple regions of Morocco to maximize variety in the EFL sample. Sampled participants were drawn from numerous universities in different cities including Mohammed V University in Rabat, Ibn Tofail University in Kenitra, Moulay Ismail University in Meknes, Abdelmalek Essaadi University in Tetouan, and Moulay Slimane University in Beni Mellal. The subjects completed the computerized RSES questionnaire by the end of the 2020 school year based on a list of pre-selected enrolled class students from various faculties. The choice of this method of data collection is explained by our inability to conduct in-class administration due to the restrictions imposed by the Corona-virus pandemic. Data were stored and processed using Microsoft Excel and Word (2007), SPSS (20), and Amos (24).

Measurement Tools

The Rosenberg Self-esteem Scale is a brief and an easy-to-administer questionnaire that consists of ten items. Five of its items are worded positively, whereas the remaining five are worded negatively (Rosenberg, 1965). The RSES has been through multiple revisions over time. For this study, we used the original version of the scale. The RSES demonstrated a good level of reliability and validity (Scheier et al., 1994) and it was proven to be deployable and reliably more useful in multiple cross-cultural contexts (Schmitt & Allik, 2005). The RSE scale ranges from "strongly disagree" to "strongly agree" on a five-point Likert scale.

Results

Data Preparation, Multicollinearity, and Normality Testing

At the outset, we conducted missing data analysis, outlier detection, normality and multicollinearity assessments. Initially, when examined, our dataset showed no missing data. The next step was outlier detection and processing. There are multiple causes for outliers and they range from errors in recording and measurement, unknown data structure, a novel phenomenon, or incorrect distribution assumption (Iglewicz & Hoaglin, 1993). At this level, data were assessed for multivariate outliers. Using a cutoff p-value of .001 as part of the screening through the Mahalanobis distance test (Tabachnick & Fidell, 2013) for multivariate assessment, two outliers were identified and removed. By examining the data graphically and numerically, there appeared to be two additional records of perfect scores that required to be removed, and thus making a total of four outliers. Regarding multicollinearity, no significant level was found since the highest Variance Inflation Factor (VIF) for self-esteem items was $VIF = 1.727$. As for multivariate normality, based on standardized summed scores, our analyses show that SE data were normally distributed, $W(204) = .987, p = .071$, according to the Shapiro-Wilk normality test.

Self-esteem: Factor Extraction, Factor Rotation, and Internal Consistency

Table 1. KMO and Bartlett's Test of Self-esteem scale items

Kaiser-Meyer-Olkin Measure of Sampling Adequacy		.837
Bartlett's Test of Sphericity	Approx. Chi-Square	374.821
	df	45
	Sig.	.000

RSES items were factor analyzed using PAF. Main indexes which consist of the Kaiser-Meyer-Olkin measure of sampling adequacy, $KMO = .83$, and Bartlett's test of Sphericity, $\chi^2(45) = 374.821$, $p < .001$, showed that SE scale items could be factorized (See Table 1).

Table 2. Initial eigenvalues, Principal axis factoring eigenvalues, Parallel Analysis-generated eigenvalues at the 95th percentile, and Velicer's average squared partial correlations of Self-esteem data

Component	Initial eigenvalues	PAF eigenvalues	Simulated eigenvalues at the 95th percentile	Average squared partial correlations
1	3.3283	2.6356	.5480	.0718
2	1.1089	.2969	.3801	.0189
3	1.0221	.1897	.2820	.0356
4	.8708	.1668	.1863	.0615
5	.8471	-.0216	.1050	.1010
6	.6990	-.0498	.0547	.1366
7	.6516	-.0800	-.0250	.1980
8	.5290	-.1618	-.9260	.2857
9	.4888	-.1900	-.1503	.5842
10	.4545	-.2420	-.2251	1

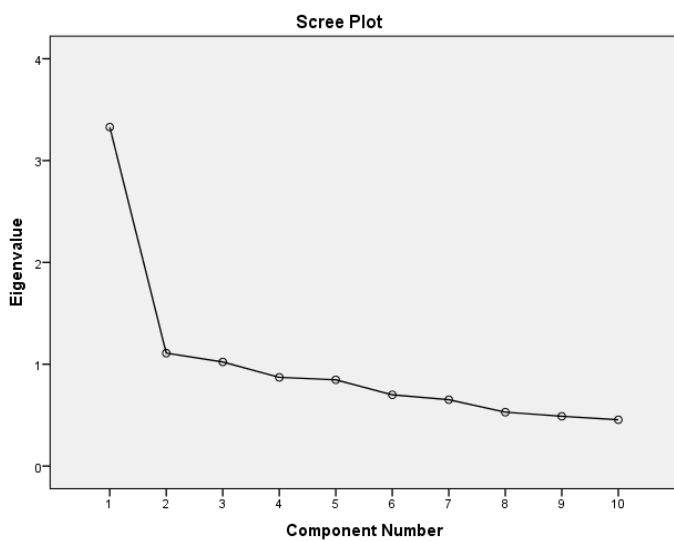

Figure 1. Scree plot of Self-esteem

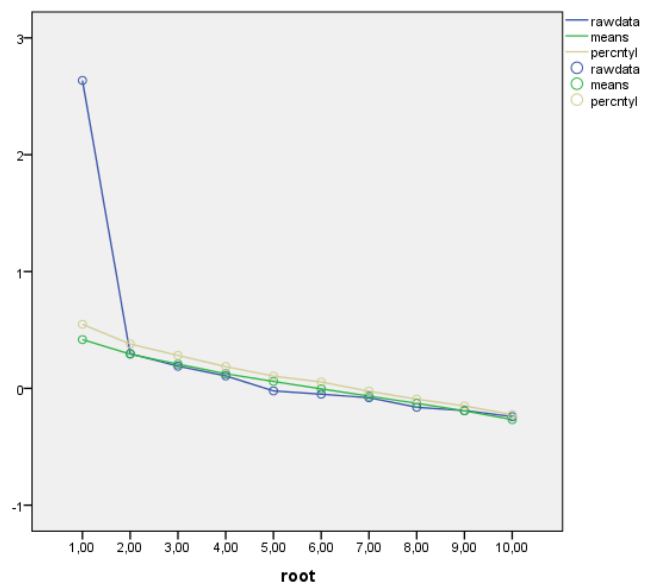

Figure 2. Initial and Simulated eigenvalues plot of Self-esteem

Initial factor analysis generated three factors (See Table 2), explaining a total of 54.593% of the variance. The scree plot also indicated a three-factor structure as well (See Figure 1) despite the analyses showing that both Velicer's minimum average partial test and parallel analysis (see Table 2 and Figure 2) yielded conclusively a one-factor solution. Results of factor extraction methods (See Table 2) by order of power i.e. Horn's PA and Velicer's MAP, in addition to PAF eigenvalues unanimously point to a one-factor solution. The internal consistency was examined using Cronbach's alpha (See Table 3).

Table 3. Descriptive statistics and Cronbach's Alpha for self-esteem

Factor	Number of Items	M(SD)	Skewness	Kurtosis	Min	Max	N	Cronbach's α
Self-esteem	10	3.57 (.56)	.10	-.28	2.10	4.8	202	.74

The alpha coefficient revealed to be acceptable. No substantial increase in alpha was achieved by eliminating items of the subscales. Table 4 shows communalities and factor loadings based on a one-factor solution the PAF extraction method.

Table 4. Unrotated one-factor solution using Principal Axis Factoring for the 10 items of the RSES

Items	Communalities	Factor loadings
All in all, I am inclined to feel that I am a failure.	.518	.720
I take a positive attitude toward myself.	.448	.669
I feel I do not have much to be proud of.	.401	.633
I certainly feel useless at times.	.351	.562
I am able to do things as well as most other people.	.278	.527
On the whole, I am satisfied with myself.	.226	.476
I feel that I have a number of good qualities	.212	.461
At times I think I am no good at all.	.121	.348
I wish I could have more respect for myself.	.101	.317
I feel that I am a person of worth, at least on an equal plane with others	.021	.145
Eigen-values		2.678
Variance		26.777
Extraction method: Principal axis factoring		
Rotation method: Unrotated		

Confirmatory Factor Analysis

Using SPSS AMOS (21), we constructed three models linking the self-esteem items along a one-dimensional structure, a two-dimensional structure and a correlated two-dimensional structure. Regarding validation, initial models can be adjusted depending on the modification indices suggested. In this case, we did not carry out that operation for reasons to be discussed in the next section.

The Hypothesized Self-esteem Models

We hypothesized three models based on one factor, independent two factors, and restrained two factors as follows:

- 1) Ten-item represented by one factor (Fig. 3);
- 2) Ten items represented by two restrained factors (positively and negatively oriented items) (Fig. 4);
- 3) Ten items represented by two independent factors (positively and negatively oriented items) (Fig. 5);

The ten items are numbered as appears in (Table 5)

Table 5. Rosenberg Self-esteem Scale Items (Rosenberg, 1965)

Item number	Items	Wording
1	On the whole, I am satisfied with myself	Positive
2	At times, I think I am no good at all	Negative
3	I feel that I have a number of good qualities	Positive
4	I am able to do things as well as most other people	Positive
5	I feel I do not have much to be proud of	Negative
6	I certainly feel useless at times	Negative
7	I feel that I'm a person of worth, at least on an equal plane with others	Positive
8	I wish I could have more respect for myself	Negative
9	All in all, I am inclined to feel that I am a failure	Negative
10	I take a positive attitude toward myself	Positive



Figure 3. Hypothesized One-factor Model of Self-esteem

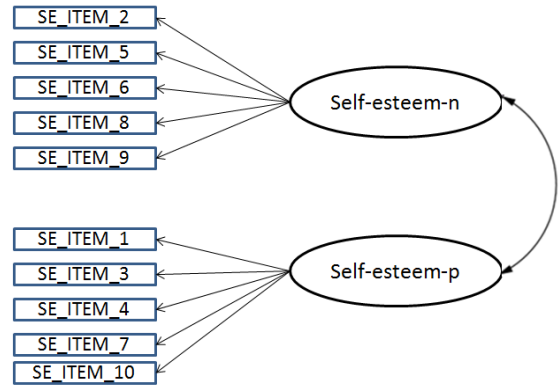

Figure 4. Hypothesized Restrained Two-factor Model of Self-esteem

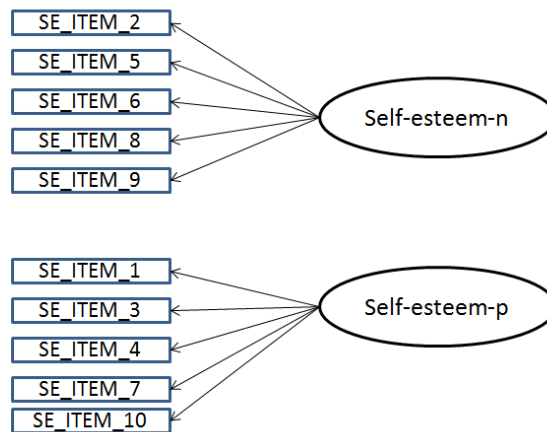

Figure 5. Hypothesized Independent Two-factor Model of Self-esteem

CFA Results

CFA results for the one-factor model ($\chi^2(35) = 46.335$, $p = .095$, CFI=.966, TLI=.957, IFI=.967, NFI=.879, RMSEA=.04, SRMR=.0476) (see Figure 6), the restrained two-factor model ($\chi^2(34) = 40.834$, $p = .195$, CFI=.980, TLI=.973, IFI=.980, NFI=.893, RMSEA=.03, SRMR=.0452) (see Figure 7) and independent two-factor model ($\chi^2(35) = 133.581$, $p < .001$, CFI=.708, TLI=.625, IFI=.717, NFI=.651, RMSEA=.12, SRMR=.1740) (see Figure 8) were obtained (See Table 6 and Table 7).

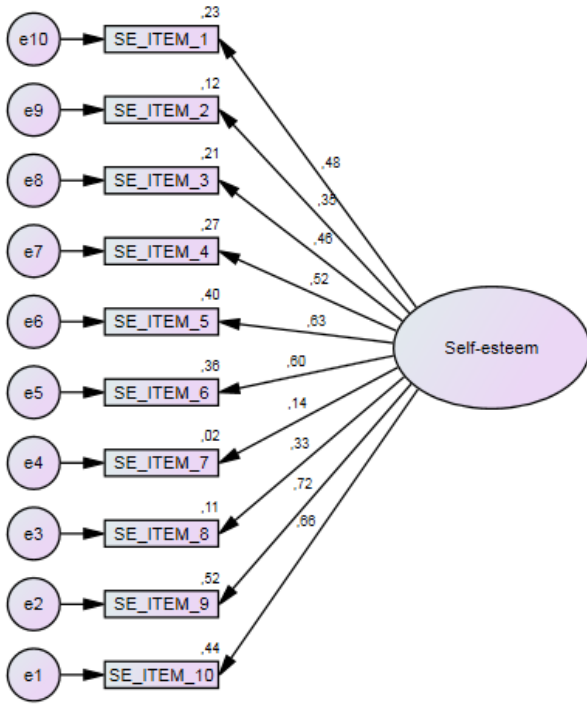

Figure 6. Final One-factor Model of Self-esteem

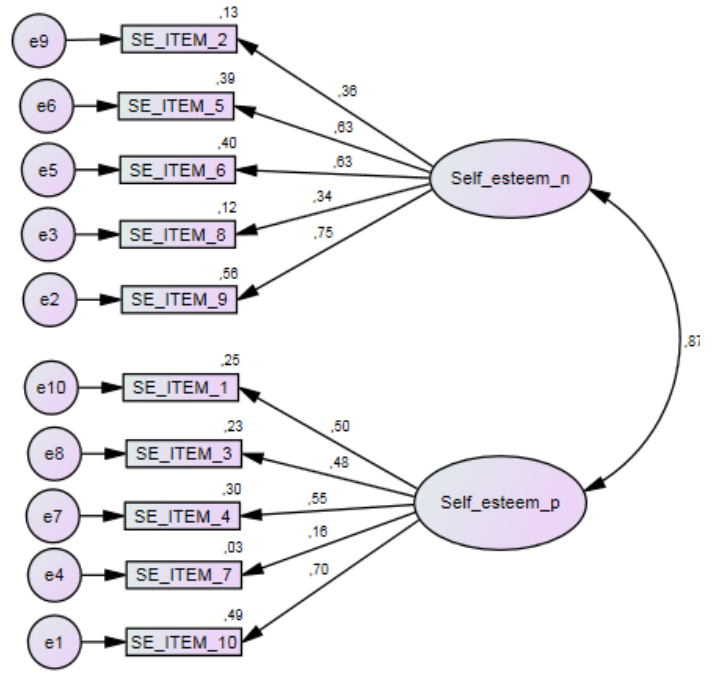

Figure 7. Final Restrained Two-factor Model of Self-esteem

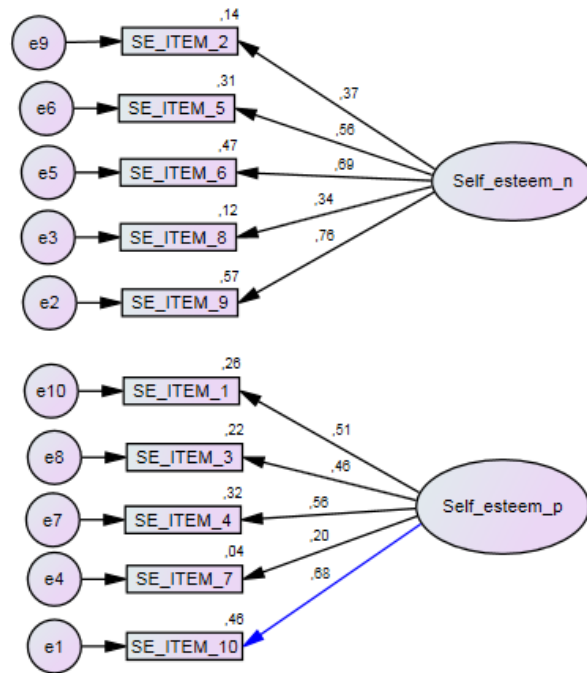

Figure 8. Final Independent Two-factor Model of Self-esteem

Table 6. Confirmatory factor analysis fit indexes of the one-factor, the restrained two-factor and the independent two factor models of Self-esteem

Models	χ^2	P	df	χ^2/df	CFI	TLI	IFI	NFI	SRMR	RMSEA
Restrained two-factor model	40.834	.195	34	1.10	.980	.973	.960	.893	.0452	.03
One-factor model	46.335	.095	35	1.32	.966	.957	.967	.879	.0476	.04
Independent two-factor model	133,581	.000	35	3.81	.708	.625	.717	.651	.1740	.12

Note. N = 202.

χ^2 = chi-square goodness of fit statistic; df =degrees of freedom;

RMSEA= root mean square error of approximation; CFI = Comparative Fit Index;

TLI = Tucker-Lewis Index; SRMR = standardized root mean square residual.

Overall, the models show acceptable to good fit-indexes (See Table 6). The third model with restrained two factors appears to have the best fit indexes.

Table 7. Standardized, unstandardized factor loadings, and standard errors for the general self-esteem factor of the Rosenberg Self-Esteem Scale – the one-factor model, the independent the two factor model and the restrained two-factor model.

Items	β			B			S.E.			P		
Item 1	.600	.895	.937	.476	.502	.510	.101	.152	.196	***	***	***
Item 2	.538	.530	.524	.352	.361	.371	.121	.117	.121	***	***	***
Item 3	.509	.742	.745	.462	.476	.464	.088	.132	.165	***	***	***
Item 4	.596	.885	.941	.519	.545	.563	.092	.141	.190	***	***	***
Item 5	.956	.906	.773	.634	.626	.555	.124	.119	.126	***	***	***
Item 6	.947	.957	1	.600	.631	.686	.129	.125	-	***	***	-
Item 7	.185	.300	.378	.144	.164	.201	.101	.148	.168	.067	.042	.024
Item 8	.540	.535	.521	.330	.340	.344	.130	.125	.129	***	***	***
Item 9	1	1	.973	.718	.747	.756	-	-	.144	-	-	***
Item 10	.667	1	1	.661	.700	.680	.083	-	-	***	-	-

The CR of the construct was calculated based on estimates in (Table 7) using a special formula by Netemeyer et al. (2003).

Internal reliability results (See Table 8) show that the highest reliability estimation is attributed to the one-factor model (CR= 0.768), whereas the restrained two-factor model (CR_N= 0.606; CR_P= 0.682) turned out to be negligibly less reliable than its unrestrained counterpart (CR_N= 0.684; CR_P= 0.612).

Table 8. Composite Reliability of Self-esteem factors in three Self-esteem models

Model	Factor	Composite Reliability
One-factor	-	0.768
Restrained two-factor model	Negative	0.682
	Positive	0.606
Independent two-factor model	Negative	0.684
	Positive	0.612

Discriminant Validity

There exist multiple ways to measure discriminant validity (Voorhees et al., 2016). Out of these many ways, one notably sophisticated and reliable method which has proven its merit is the hetero-trait mono-trait (HTMT) ratio by Henseler et al. (2015). For our purposes, we use the HTMT.

Using this method, Table 9 and Table 10 show the results of the pairwise HTMT ratio for both two factors for each model. The results yielded the same value for both models (.868) indicating acceptable discriminant validity.

Table 9. HTMT ratio of the independent RSE two-factor model

Factor	1	2
Self-esteem-n	-	
Self-esteem-p	.868	-

Table 10. HTMT ratio of the correlated RSE two-factor model

Factor	1	2
Self-esteem-n	-	
Self-esteem-p	.868	-

Discussion

We started with data preparation consisting of missing data analysis, multivariate outlier identification and removal, in addition to multicollinearity and multivariate normality testing. The next step was to evaluate the hypothesized SE models through CFA and discriminant validity.

Methods of factor analysis may not necessarily strongly converge in terms of results because there are multiple methods of factor retention (Velicer & Jackson, 1990). The most widely used method is the Kaiser-Guttman rule which tends to overestimate the number of latent factors (Hayton et al., 2004), and so does Cattell's method of the scree plot (Cattell, 1966). However, both methods have shown serious flaws since they tend to overestimate the number of components (Zwick & Velicer, 1986). Having said that, two of the most compelling and reliable alternative methods are Horn's (1965) PA and Velicer's (1976) MAP Test. The MAP Test has been demonstrably shown to be more reliable than the Kaiser-Guttman rule and scree plot, and it is only superseded in performance by PA and other similar approaches (Ledesma & Valero-Mora, 2007). But before we proceed, variables factorizability is the initial step.

Regarding factorizability, the indexes are the KMO measure and the Bartlett's Sphericity test result. Researchers report that a KMO value of .60 is considered acceptable (Kaiser, 1974). Therefore, the obtained KMO result of .837 (See Table 1) is considered good by comparison. Furthermore, Bartlett's Sphericity test was found statistically significant, $\chi^2(45) = 374.821, p < .001$.

After that, using PAF to eliminate the influence of error variance, initial factor analysis results (See Table 4) and the scree plot (See Figure 1) yielded a one-factor solution based on the corresponding eigenvalues. Similarly, both the MAP and PA tests yielded a one-factor solution (See Table 4 and Figure 1). We opted for a one-factor solution mainly because by far the most reliable statistical factor analytical test we deployed is PA (Courtney & Gordon, 2013). Although we are at an exploratory stage, we have to keep in mind that the competitive two-factor structure and three-factor structure have relatively less considerable previous theoretical support and that there is ample evidence in support of the one-factor structure (Huang & Dong, 2012).

At this stage, there remains the question of factor rotation method, but since we have conclusively a one-factor structure, the factor solution can only be unrotated. Factor analysis showed that the items loaded variably onto the one factor as shown in Table 4. The ten items relate to how a person feels about and views themselves and reflects how persons evaluate themselves in terms of their qualities and worth derived from it particularly in comparison with others. Using Cronbach's alpha (1947, 1951), the internal consistency of the scale items was found to be good, $\alpha = .74$ (See Table 3), according to Nunnally (1978).

CFA plays an instrumentally essential role in the validation of measurement models (MacCallum & Austin, 2000). Brown and Moore (2012) succinctly put it when they emphasize that: "CFA is an indispensable analytic tool for construct validation. The results of CFA can provide compelling evidence of the convergent, and discriminant validity of theoretical constructs." (p.2) Using CFA, we set out to evaluate and validate three hypothesized competing models for the RSES, one of which corresponds to a one-factor structure while the other two correspond to a two-factor structure as appears in (Figures 3, 4 and 5).

Initial analysis showed that data can be safely factorizable according to the KMO measure, $KMO = .837$, and Bartlett's sphericity test, $\chi^2(45) = 374.821, p < .001$ (See Table 1). Subsequently, we proceeded to answer the question of the number of factors. To determine that, PAF eigenvalues and PA simulated eigenvalues were extracted as MAP average squared partial correlations were generated (See Table 2). Results show that initial eigenvalues (Table 2) and the scree test (Figure 1) yielded three factors based on the Kaiser-Guttman rule (Zwick & Velicer, 1986), while factor analysis using PAF, the MAP test and PA unanimously concluded one factor.

Using PAF eigenvalues, results suggested the retention of one factor as numerically appears in Table 2 since only one factor satisfies the K1 rule. As for the MAP test, the smallest average squared correlation coefficient is the cut-off for the number of retainable factors. In other words, the proposed stopping point is the least average partial correlation value (Velicer, 1976) which is in this case .0189. This value is associated to the second component, all of which translates into retaining one factor. The third and last method is PA. The number of factors to retain corresponds to the number of observed eigenvalues that are greater than their simulated counterparts at the 95th percentile (Ledesma & Valero-Mora, 2007).

The result was that one factor was extracted based on an unrotated solution (See Table 4). This step comes before model construction. Scale items in the constructed models were numbered as in (Table 5) as they appeared initially in

(Rosenberg, 1965). This item order was adopted for the first model. For the second and third models, negatively oriented items and positively oriented items were respectively separately associated with one negative factor and one positive factor (See Figures 4 and 5).

Several model fit indices and their criteria were used to examine the goodness-of-fit of the models and they include most notably the Tucker-Lewis Index (TLI; Tucker & Lewis, 1973), comparative fit index (CFI; Bentler, 1990), standardized root mean residual (SRMR), and root mean square error of approximation (RMSEA). We reported data in conformance with the guidelines and recommendations which appear in (Jackson et al., 2009) and the models were evaluated using values of indexes by Brown (2015): RMSEA (≤ 0.06 , 90% CI ≤ 0.06), SRMR (≤ 0.08), CFI (≥ 0.95), TLI (≥ 0.95), and the chi-square/df ratio less than 3 (Kline, 2015).

CFA and TLI were acceptable to good for the one-factor model and the constrained two-factor model, but low to moderate for the independent two-constrained model, when SRMR and RMSEA were good for both the one-factor model and the constrained two-factor model but fell below the standard for the unconstrained two-factor model (See Table 6). The remaining statistic is the χ^2 . We emphasized the other indices for the simple reason that the χ^2 is very sensitive to sample size and should not be relied upon as the only basis for assessment for acceptance or rejection of a model (Schermelleh-Engel et al., 2003). The balanced and recommended approach to evaluate model fitness is to rely upon an ensemble of fit indexes to attempt to capture the complexity of the model tested (Fornell & Larcker, 1981).

CFA results indicate sufficiently good model fit for the three hypothesized structures. The best-fitting model is the restrained two-factor model while the least-fitting is the unrestrained two-factor model. The one-factor model appears to fit the data better than its uncorrelated two-factor counterpart. However, correlating the independent two-factor model improves considerably its fit indexes.

In conformance with earlier reports, results support both the one-dimensional structure (e.g., Eklund et al., 2018; Franck et al., 2008; Huang & Dong, 2012; Mayordomo et al., 2020; Rosenberg, 1965; Salerno et al., 2017; Zimprich et al., 2005) and the two-dimensional structure (e.g., Bae et al., 2014; Boduszek et al., 2013; Goldsmith, 1986; Mayordomo et al., 2020; Salerno et al., 2017; Supple & Plunkett, 2011). As there is no definitive answer as to what constitutes the best conception of the RSES given that solid evidence does not appear to favor one structure over the other, conclusions about the factor structure remain context-bound.

After evaluating the model fitness, we calculated the composite reliability (CR) for all factors. In this respect, some researchers have recommended a rigorous level of .70 for CR (Fornell & Larcker, 1981; Nunkoo & Ramkissoon, 2011). The CR level of the one-factor model is above the recommended threshold contrary to those of both the independent and restrained two-factor models occurring slightly below it for all composite factors (See Table 9). The one-factor model demonstrates comparatively better internal consistency.

Researchers have attempted to understand what it is fundamentally that contributes to making different structures of the RSES. It turns out that wording plays a significant role in shaping the structure of the RSES. Greenberger et al. (2003) conducted a vital study whereby they found that rewording items positively or negatively lead to a one-dimensional structure, and thereby attributed the effect producing two dimensions to item wording. However, this approach used modified item wording, which requires our estimation validation before use. In our case, we limited our study to the RSES as used initially by its authors and countless others after proving validity almost consistently.

Henseler et al.'s (2015) HTMT approach can be used to strengthen established validity mainly at the convergent validity level. Along with construct reliability, the results of the pairwise HTMT ratio demonstrated for both factors for both models (Table 9 and Table 10) that the RSES sub-constructs have acceptable discriminant validity (restrained two-factor model: .868, Independent two-factor model: .868).

In summary, discriminant validity showed that the negative and the positive RSES factors are distinct. CFA yielded converging results showing that the one-factor RSES model is a good fit for the data. Further, the one-factor model over-performed the independent two-factor model but it underperformed the restrained two-factor model which was revealed to be the best fitting model of all three, and thus confirming partly hypothesis one (H1) and fully hypothesis two (H2) as recapitulated here:

Table 11. Summary of the hypothesis testing

Hypothesis	Result
The one-factor model of the RSES is better fitting than both two-factor models.	Partly confirmed
The restrained two-factor model of the RSES is more fitting than the independent two-factor model.	Confirmed

Conclusion

To sum up, a preliminary factor analysis using PAF was conducted before performing CFA of the RSES. Initial analysis and mainly PA yielded a one-factor solution. Through CFA, we evaluated three models of the RSES: a one-factor model, a two-factor model and an enhanced version of the two-factor model through correlating both factors. The results

revealed that two out of the three models did show good fit-indexes. Our findings also demonstrated the superiority of the one-factor model in comparison with its two-factor counterpart before modification and the modified version of the two-factor model however turned out to be better fitting than the other two models. Despite that, the one-factor model showed the best CR. In summary, we conclude that as is, the RSES is readily deployable in the Moroccan context both as a one unified and global construct and a two-dimensional construct.

Recommendations

Although we have not conducted a thorough exploratory factor analysis per se, one crucial step as part of recommendations for future research is to dedicate a separate database for each type of type of factor analysis, namely exploratory and confirmatory (Henson & Roberts, 2006) for more reliable conclusions. Further, another recommendation is to conduct convergent and discriminant validity tests using more representative datasets in terms of sampling where it is far more unlikely to have low communalities and low factor loading since it is very difficult to establish good convergent validity in that case. Similarly, it is highly advisable to culturally adapt the RSES scale to the Moroccan linguistic and cultural context using adequate procedures. It is likewise important to recommend that any adapted version of the RSES to Arabic or any other local language in Morocco be the object of longitudinal studies for a comprehensive evaluation of the reliability of the instrument measurement in question. Finally, we encourage researchers to replicate our study under both similar and different circumstances in an attempt to better evaluate the fitness of different RSES models in the Moroccan context.

Limitations

Every research work ever produced is perfectible. This study is no exception by the same token. One apparent limitation of the present study is the sample size. To remedy this, it is suggested that researchers have a larger sample as often advised in factor analysis studies (e.g., Tabachnick & Fidell, 2013). Another limitation is linked to the generalizability of our findings and the fact that is they are constrained by the use of a university student sample and in this context it holds that the more accommodating and diverse sample is the better the results are in principle. Further, validity-wise, a RSES adaptation to one of the local languages remains the adequate recourse although the target sample was understandably very well qualified to take English version of the RSES which is how the study was designed. The last limitation is the lack of previous research in factor analysis studies using the RSES both exploratory and confirmatory. While the present work constitutes a precedent in Morocco as far as our review of literature goes, benchmarking results was not possible in the circumstances under which the study was conducted.

Authorship Contribution Statement

Abdelouahed Bouih: Conceptualization, analysis and writing. Driss Benattabou: Supervision, editing, and finalization. Bendaoud Nadif, Mohamed Benhima and Ismail Benfilali: Editing and validation.

References

- Abdel-Khalek, A. M., Korayem, A. S., & El-Nayal, M. A. (2012). Self-esteem among college students from four Arab countries. *Psychological Reports, 110*(1), 297–303. <https://doi.org/10.2466/07.09.17.PR0.110.1.297-303>
- Abu-Saad, I. (1999). Self-esteem among Arab adolescents in Israel. *The Journal of social psychology, 139*(4), 479–486. <https://doi.org/10.1080/00224549909598407>
- Al Khatib, S. A. (2012). Exploring the relationship among loneliness, self-esteem, self-efficacy and gender in United Arab Emirates college students. *Europe's Journal of Psychology, 8*(1), 159–181. <https://doi.org/10.5964/ejop.v8i1.301>
- Aluja, A., Rolland, J. P., García, L. F., & Rossier, J. (2007). Dimensionality of the Rosenberg Self-Esteem Scale and its relationships with the three-and the five-factor personality models. *Journal of Personality Assessment, 88*(2), 246–249. <https://doi.org/10.1080/00223890701268116>
- Antonucci, T. C., & Jackson, J. S. (1983). Physical health and self-esteem. *Family & Community Health: The Journal of Health Promotion & Maintenance, 6*(2), 1–9. <https://doi.org/10.1097/00003727-198306020-00004>
- Bae, H. N., Choi, S. W., Yu, J. C., & Lee, J. S. (2014). Reliability and validity of the Korean version of the Rosenberg Self-Esteem Scale (K-RSES) in adult. *Mood Emot, 12*(1), 43–49.
- Baron, R. A., & Byrne, D. E. (1991). *Social psychology: Understanding human interaction*. Allyn and Bacon.
- Baumeister, R. F., & Tice, D. M. (1985). Self-esteem and responses to success and failure: Subsequent performance and intrinsic motivation. *Journal of personality, 53*(3), 450–467. <https://doi.org/10.1111/j.1467-6494.1985.tb00376.x>
- Beeber, L. S., Seeherunwong, A., Schwartz, T., Funk, S. G., & Vongsirimas, N. (2007). Validity of the Rosenberg Self-esteem Scale in Young Women from Thailand and the USA. *Thai Journal of Nursing Research, 11*(4), 240–250.

- Bentler, P. M. (1990). Comparative fit indexes in structural models. *Psychological bulletin*, 107(2), 238–246. <https://doi.org/10.1037/0033-2909.107.2.238>
- Boduszek, D., Hyland, P., Dhingra, K., & Mallett, J. (2013). The factor structure and composite reliability of the Rosenberg Self-Esteem Scale among ex-prisoners. *Personality and individual differences*, 55(8), 877–881. <https://doi.org/10.1016/j.paid.2013.07.014>
- Branden, N., & Archibald, S. (1982). *The psychology of self-esteem*. Bantam Books.
- Brown, H. D. (2001). *Teaching by principles: An interactive approach to language pedagogy*. Longman.
- Brown, H. D. (2006). *Principles of language learning and teaching* (5th ed.). Longman.
- Brown, T. A. (2015). *Confirmatory factor analysis for applied research* (2nd ed.). The Guilford Press.
- Brown, T. A., & Moore, M. T. (2012). Confirmatory factor analysis. In R. H. Hoyle (Ed.), *Handbook of structural equation modeling* (pp. 361–379). The Guilford Press.
- Cast, A. D., & Burke, P. J. (2002). A theory of self-esteem. *Social forces*, 80(3), 1041–1068. <https://doi.org/10.1353/sof.2002.0003>
- Cattell, R. B. (1966). The scree test for the number of factors. *Multivariate behavioral research*, 1(2), 245–276. https://doi.org/10.1207/s15327906mbr0102_10
- Corwyn, R. F. (2000). The factor structure of global self-esteem among adolescents and adults. *Journal of Research in Personality*, 34(4), 357–379. <https://doi.org/10.1006/jrpe.2000.2291>
- Courtney, M., & Gordon, R. (2013). Determining the number of factors to retain in EFA: Using the SPSS R-menu v2 0 to make more judicious estimations. *Practical Assessment, Research, and Evaluation*, 18(1), 8–22. <https://doi.org/10.7275/9cf5-2m72>
- Cronbach, L. J. (1947). Test “reliability”: Its meaning and determination. *Psychometrika*, 12(1), 1–16. <https://doi.org/10.1007/BF02289289>
- Cronbach, L. J. (1951). Coefficient alpha and the internal structure of tests. *Psychometrika*, 16(3), 297–334. <https://doi.org/10.1007/BF02310555>
- Donnellan, M. B., Trzesniewski, K. H., & Robins, R. W. (2011). *Self-esteem: Enduring issues and controversies*. In T. Chamorro-Premuzic, S. von Stumm, & A. Furnham (Eds.), *The Wiley-Blackwell handbooks of personality and individual differences. The Wiley-Blackwell handbook of individual differences* (pp. 718–746). Wiley Blackwell. <https://doi.org/10.1002/9781444343120.ch28>
- Dornyei, Z., & Ryan, S. (2015). *The psychology of the language learner revisited*. Routledge. <https://doi.org/10.4324/9781315779553>
- Eklund, M., Bäckström, M., & Hansson, L. (2018). Psychometric evaluation of the Swedish version of Rosenberg’s self-esteem scale. *Nordic journal of psychiatry*, 72(5), 318–324. <https://doi.org/10.1080/08039488.2018.1457177>
- Fleming, J. S., & Courtney, B. E. (1984). The dimensionality of self-esteem: II. Hierarchical facet model for revised measurement scales. *Journal of Personality and Social Psychology*, 46(2), 404–421. <https://doi.org/10.1037/0022-3514.46.2.404>
- Fornell, C., & Larcker, D. F. (1981). Structural equation models with unobservable variables and measurement error: Algebra and statistics. *Journal of Marketing Research*, 12(3), 382–388. <https://doi.org/10.1177/002224378101800313>
- Franck, E., De Raedt, R., Barbez, C., & Rosseel, Y. (2008). Psychometric properties of the Dutch Rosenberg self-esteem scale. *Psychologica Belgica*, 48(1), 25–35. <https://doi.org/10.5334/pb-48-1-25>
- García, J. A., y Olmos, F. C., Matheu, M. L., & Carreño, T. P. (2019). Self esteem levels vs global scores on the Rosenberg self-esteem scale. *Heliyon*, 5(3), e01378. <https://doi.org/10.1016/j.heliyon.2019.e01378>
- Gnamb, T., Scharl, A., & Schroeders, U. (2018). The structure of the Rosenberg self-esteem scale. *Zeitschrift für Psychologie*, 226(1). <https://doi.org/10.1027/2151-2604/a000317>
- Gnamb, T., & Schroeders, U. (2020). Cognitive abilities explain wording effects in the Rosenberg Self-Esteem Scale. *Assessment*, 27(2), 404–418. <https://doi.org/10.1177/1073191117746503>
- Goldsmith, R. E. (1986). Dimensionality of the Rosenberg self-esteem scale. *Journal of Social Behavior and Personality*, 1(2), 253–264.

- Greenberger, E., Chen, C., Dmitrieva, J., & Farruggia, S. P. (2003). Item-wording and the dimensionality of the Rosenberg Self-Esteem Scale: Do they matter?. *Personality and individual differences, 35*(6), 1241–1254. [https://doi.org/10.1016/S0191-8869\(02\)00331-8](https://doi.org/10.1016/S0191-8869(02)00331-8)
- Hair, J. F., Black, W. C., Babin, B. J., & Anderson, R. E. (2019). *Multivariate data analysis*. Cengage Learning.
- Halama, P. (2008). Confirmatory factor analysis of Rosenberg Self-Esteem Scale in a sample of Slovak high school and university students. *Studia Psychologica, 50*(3), 255–266.
- Harris, M. A., & Orth, U. (2020). The link between self-esteem and social relationships: A meta-analysis of longitudinal studies. *Journal of personality and social psychology, 119*(6), 1459–1477. <https://doi.org/10.1037/pspp0000265>
- Hayton, J. C., Allen, D. G., & Scarpello, V. (2004). Factor retention decisions in exploratory factor analysis: A tutorial on parallel analysis. *Organizational research methods, 7*(2), 191–205. <https://doi.org/10.1177/1094428104263675>
- Henseler, J., Ringle, C. M., & Sarstedt, M. (2015). A new criterion for assessing discriminant validity in variance-based structural equation modeling. *Journal of the academy of marketing science, 43*(1), 115–135. <https://doi.org/10.1007/s11747-014-0403-8>
- Henson, R. K., & Roberts, J. K. (2006). Use of exploratory factor analysis in published research: Common errors and some comment on improved practice. *Educational and Psychological measurement, 66*(3), 393–416. <https://doi.org/10.1177/0013164405282485>
- Higgins, E. T. (1996). The "self digest": Self-knowledge serving self-regulatory functions. *Journal of Personality and Social Psychology, 71*(6), 1062–1083. <https://doi.org/10.1037/0022-3514.71.6.1062>
- Horn, J. L. (1965). A rationale and test for the number of factors in factor analysis. *Psychometrika, 30*(2), 179–185. <https://doi.org/10.1007/BF02289447>
- Huang, C., & Dong, N. (2012). Factor structures of the Rosenberg Self-Esteem Scale: A meta-analysis of pattern matrices. *European Journal of Psychological Assessment, 28*(2), 132–138. <https://doi.org/10.1027/1015-5759/a000101>
- Iglewicz, B., & Hoaglin, D. C. (1993). *How to detect and handle outliers*. ASQ Press.
- Jackson, D. L., Gillaspay, J. A., Jr., & Purc-Stephenson, R. (2009). Reporting practices in confirmatory factor analysis: An overview and some recommendations. *Psychological Methods, 14*(1), 6–23. <https://doi.org/10.1037/a0014694>
- Kaiser, H. F. (1974). An index of factorial simplicity. *Psychometrika, 39*(1), 31–36. <https://doi.org/10.1007/BF02291575>
- Kielkiewicz, K., Mathúna, C. Ó., & McLaughlin, C. (2020). Construct validity and dimensionality of the Rosenberg Self-Esteem scale and its association with spiritual values within Irish population. *Journal of Religion and Health, 59*(1), 381–398. <https://doi.org/10.1007/s10943-019-00821-x>
- Kline, R. B. (2015). *Principles and practice of structural equation modeling*. Guilford publications.
- Krauss, S., Orth, U., & Robins, R. W. (2020). Family environment and self-esteem development: A longitudinal study from age 10 to 16. *Journal of Personality and Social Psychology, 119*(2), 457–478. <https://doi.org/10.1037/pspp0000263>
- Leary, M. R., & Baumeister, R. F. (2000). The nature and function of self-esteem: Sociometer theory. In M. P. Zanna (Ed.), *Advances in experimental social psychology, (Vol. 32, pp. 1–62)*. Academic Press. [https://doi.org/10.1016/S0065-2601\(00\)80003-9](https://doi.org/10.1016/S0065-2601(00)80003-9)
- Ledesma, R. D., & Valero-Mora, P. (2007). Determining the number of factors to retain in EFA: An easy-to-use computer program for carrying out parallel analysis. *Practical assessment, research, and evaluation, 12*(1), 1–11. <https://doi.org/10.7275/wjnc-nm63>
- MacCallum, R. C., & Austin, J. T. (2000). Applications of structural equation modeling in psychological research. *Annual review of psychology, 51*(1), 201–226. <https://doi.org/10.1146/annurev.psych.51.1.201>
- Marsh, H. W., Scalas, L. F., & Nagengast, B. (2010). Longitudinal tests of competing factor structures for the Rosenberg Self-Esteem Scale: traits, ephemeral artifacts, and stable response styles. *Psychological assessment, 22*(2), 366–381. <https://doi.org/10.1037/a0019225>
- Martín-Albo, J., Núñez, J. L., Navarro, J. G., & Grijalvo, F. (2007). The Rosenberg Self-Esteem Scale: Translation and validation in university students. *The Spanish journal of psychology, 10*(2), 458–467. <https://doi.org/10.1017/S1138741600006727>

- Mayordomo, T., Gutierrez, M., & Sales, A. (2020). Adapting and validating the Rosenberg Self-Esteem Scale for elderly Spanish population. *International Psychogeriatrics*, 32(2), 183-190. <https://doi.org/10.1017/S1041610219001170>
- McKay, M. T., Boduszek, D., & Harvey, S. A. (2014). The Rosenberg Self-Esteem Scale: A bifactor answer to a two-factor question? *Journal of personality assessment*, 96(6), 654–660. <https://doi.org/10.1080/00223891.2014.923436>
- Monteiro, R. P., Coelho, G. L. D. H., Hanel, P. H., de Medeiros, E. D., & da Silva, P. D. G. (2022). The efficient assessment of self-esteem: Proposing the brief Rosenberg Self-Esteem Scale. *Applied Research in Quality of Life*, 17(2), 931-947. <https://doi.org/10.1007/s11482-021-09936-4>
- Netemeyer, R. G., Bearden, W. O., & Sharma, S. (2003). *Scaling procedures: Issues and applications*. Sage Publications. <https://doi.org/10.4135/9781412985772>
- Nunkoo, R., & Ramkissoon, H. (2011). Developing a community support model for tourism. *Annals of Tourism Research*, 38(3), 964–988. <https://doi.org/10.1016/j.annals.2011.01.017>
- Nunnally, J. C. (1978). *Psychometric theory* (2nd ed.). McGraw-Hill.
- Orth, U., Erol, R. Y., & Luciano, E. C. (2018). Development of self-esteem from age 4 to 94 years: A meta-analysis of longitudinal studies. *Psychological bulletin*, 144(10), 1045-1080. <https://doi.org/10.1037/bul0000161>
- Owens, T. J. (1993). Accentuate the positive-and the negative: Rethinking the use of self-esteem, self-deprecation, and self-confidence. *Social Psychology Quarterly*, 54(4), 288–299. <https://doi.org/10.2307/2786665>
- Pearlin, L. I., & Schooler, C. (1978). The structure of coping. *Journal of health and social behavior*, 19(1), 2–21. <https://doi.org/10.2307/2136319>
- Perez-Gramaje, A. F., Garcia, O. F., Reyes, M., Serra, E., & Garcia, F. (2020). Parenting styles and aggressive adolescents: Relationships with self-esteem and personal maladjustment. *The European Journal of Psychology Applied to Legal Context*, 12(1), 1–10. <https://doi.org/10.5093/ejpalc2020a1>
- Pierce, J. L., Gardner, D. G., Cummings, L. L., & Dunham, R. B. (1989). Organization-based self-esteem: Construct definition, measurement, and validation. *Academy of Management journal*, 32(3), 622–648. <https://doi.org/10.5465/256437>
- Pullmann, H., & Allik, J. (2000). The Rosenberg Self-Esteem Scale: Its dimensionality, stability and personality correlates in Estonian. *Personality and Individual Differences*, 28(4), 701–715. [https://doi.org/10.1016/S0191-8869\(99\)00132-4](https://doi.org/10.1016/S0191-8869(99)00132-4)
- Rosenberg, M. (1965). *Society and the Adolescent Self-Image*. Princeton University Press. <https://doi.org/10.1515/9781400876136>
- Rosenberg, M., & Kaplan, H. B. (1982). *Social psychology of the self-concept*. H. Davidson.
- Rosenberg, M., Schooler, C., Schoenbach, C., & Rosenberg, F. (1995). Global self-esteem and specific self-esteem: Different concepts, different outcomes. *American sociological review*, 60(1), 141–156. <https://doi.org/10.2307/2096350>
- Rossier, J., Rochat, S., Sovet, L., & Bernaud, J. L. (2022). Validation of a French version of the Career Decision-Making Difficulties Questionnaire: Relationships with self-esteem and self-efficacy. *Journal of Career Development*, 49(4), 906-921. <https://doi.org/10.1177/08948453211009975>
- Roth, M., & Altmann, T. (2020). A comparison of the predictive validity of self-esteem level and directly measured self-esteem stability in the temporal prediction of psychological distress. *Frontiers in Psychology*, 11, Article 1770. <https://doi.org/10.3389/fpsyg.2020.01770>
- Roth, M., Decker, O., Herzberg, P. Y., & Brähler, E. (2008). Dimensionality and norms of the Rosenberg Self-Esteem Scale in a German general population sample. *European Journal of Psychological Assessment*, 24(3), 190–197. <https://doi.org/10.1027/1015-5759.24.3.190>
- Rubio, R. A. (2007). *Self-esteem and foreign language learning*. Cambridge Scholars Publishing.
- Salerno, L., Ingoglia, S., & Coco, G. L. (2017). Competing factor structures of the Rosenberg Self-Esteem Scale (RSES) and its measurement invariance across clinical and non-clinical samples. *Personality and Individual Differences*, 113, 13-19. <https://doi.org/10.1016/j.paid.2017.02.063>
- Savaya, R. (1998). Associations among economic need, self-esteem, and Israeli Arab women's attitudes toward and use of professional services. *Social Work*, 43(5), 445–454. <https://doi.org/10.1093/sw/43.5.445>

- Scheier, M. F., Carver, C. S., & Bridges, M. W. (1994). Distinguishing optimism from neuroticism (and trait anxiety, self-mastery, and self-esteem): A reevaluation of the Life Orientation Test. *Journal of personality and social psychology*, 67(6), 1063–1078. <https://doi.org/10.1037//0022-3514.67.6.1063>
- Schermelleh-Engel, K., Moosbrugger, H., & Müller, H. (2003). Evaluating the fit of structural equation models: Tests of significance and descriptive goodness-of-fit measures. *Methods of psychological research online*, 8(2), 23–74.
- Schmitt, D. P., & Allik, J. (2005). Simultaneous administration of the Rosenberg Self-Esteem Scale in 53 nations: Exploring the universal and culture-specific features of global self-esteem. *Journal of personality and social psychology*, 89(4), 623–642. <https://doi.org/10.1037/0022-3514.89.4.623>
- Shevlin, M. E., Bunting, B. P., & Lewis, C. A. (1995). Confirmatory factor analysis of the Rosenberg self-esteem scale. *Psychological Reports*, 76(3), 707–710. <https://doi.org/10.2466/pr0.1995.76.3.707>
- Supple, A. J., & Plunkett, S. W. (2011). Dimensionality and validity of the Rosenberg Self-Esteem Scale for use with Latino adolescents. *Hispanic Journal of Behavioral Sciences*, 33(1), 39–53. <https://doi.org/10.1177/0739986310387275>
- Supple, A. J., Su, J., Plunkett, S. W., Peterson, G. W., & Bush, K. R. (2013). Factor structure of the Rosenberg self-esteem scale. *Journal of Cross-Cultural Psychology*, 44(5), 748–764. <https://doi.org/10.1177/0022022112468942>
- Tabachnick, B. G., & Fidell, L. S. (2013). *Using Multivariate Statistics* (6th ed.). Pearson Publication.
- Tafarodi, R. W., & Swann, W. B., Jr. (1995). Self-liking and self-competence as dimensions of global self-esteem: Initial validation of a measure. *Journal of Personality Assessment*, 65(2), 322–342. https://doi.org/10.1207/s15327752jpa6502_8
- Tomas, J. M., & Oliver, A. (1999). Rosenberg's self-esteem scale: Two factors or method effects. *Structural Equation Modeling: A Multidisciplinary Journal*, 6(1), 84–98. <https://doi.org/10.1080/10705519909540120>
- Tucker, L. R., & Lewis, C. (1973). A reliability coefficient for maximum likelihood factor analysis. *Psychometrika*, 38(1), 1–10. <https://doi.org/10.1007/BF02291170>
- Vasconcelos-Raposo, J., Fernandes, H. M., Teixeira, C. M., & Bertelli, R. (2012). Factorial validity and invariance of the Rosenberg Self-Esteem Scale among Portuguese youngsters. *Social Indicators Research*, 105(3), 483–498. <https://doi.org/10.1007/s11205-011-9782-0>
- Velicer, W. F. (1976). Determining the number of components from the matrix of partial correlations. *Psychometrika*, 41(3), 321–327. <https://doi.org/10.1007/BF02293557>
- Velicer, W. F., & Jackson, D. N. (1990). Component analysis versus common factor analysis: Some issues in selecting an appropriate procedure. *Multivariate behavioral research*, 25(1), 1–28. https://doi.org/10.1207/s15327906mbr2501_1
- Verkuyten, M. (2003). Discourses about ethnic group (de-) essentialism: Oppressive and progressive aspects. *British Journal of Social Psychology*, 42(3), 371–391. <https://doi.org/10.1348/014466603322438215>
- Voorhees, C. M., Brady, M. K., Calantone, R., & Ramirez, E. (2016). Discriminant validity testing in marketing: An analysis, causes for concern, and proposed remedies. *Journal of the Academy of Marketing Science*, 44(1), 119–134. <https://doi.org/10.1007/s11747-015-0455-4>
- Wongpakaran, T., & Wongpakaran, N. (2011). Confirmatory factor analysis of Rosenberg Self-Esteem Scale: A study of Thai student sample. *Journal of the Psychiatrist Association of Thailand*, 56(1), 59-70. [In Thai] <https://bit.ly/3VWmYJK>
- Xu, M. L., & Leung, S. O. (2018). Effects of varying numbers of Likert scale points on factor structure of the Rosenberg Self-Esteem Scale. *Asian Journal of Social Psychology*, 21(3), 119-128. <https://doi.org/10.1111/ajsp.12214>
- Zimprich, D., Perren, S., & Hornung, R. (2005). A two-level confirmatory factor analysis of a modified Rosenberg self-esteem scale. *Educational and Psychological Measurement*, 65(3), 465–481. <https://doi.org/10.1177/0013164404272487>
- Zwick, W. R., & Velicer, W. F. (1986). Comparison of five rules for determining the number of components to retain. *Psychological Bulletin*, 99(3), 432–442. <https://doi.org/10.1037/00332909.99.3.432>